

IB840

Socket 478 Pentium 4
Intel 865G Chipset
Full Size CPU Card

USER'S MANUAL

Version 1.0

Acknowledgments

Award is a registered trademark of Award Software International, Inc.

PS/2 is a trademark of International Business Machines Corporation.

Intel and Pentium 4 are registered trademarks of Intel Corporation.

Microsoft Windows is a registered trademark of Microsoft Corporation.

Winbond is a registered trademark of Winbond Electronics Corporation.

All other product names or trademarks are properties of their respective owners.

Table of Contents

Introduction	1
Checklist.....	1
Product Description	2
Specifications.....	3
Product Name	3
Board Dimensions.....	4
Installations	6
Installing the CPU.....	7
ATX Power Installation	8
Installing the Memory	8
Setting the Jumpers.....	9
Connectors on IB840	18
BIOS Setup	29
Drivers Installation	53

This page is intentionally left blank.

Introduction

Checklist

Your IB840 Pentium 4 CPU card package should include the items listed below:

- The IB840 CPU Card
- This User's Manual
- 1 IDE Ribbon Cable
- 1 Floppy Ribbon Connector
- SATA Power Cord
- SATA Cable
- 2 Serial Port Ribbon Cable and 1 Parallel Port Attached to a Mounting Bracket
- 1 Y-Cable supporting a PS/2 Keyboard and a PS/2 Mouse
- 1 CD containing the following:
 - Chipset Drivers
 - Flash Memory Utility
- Optional audio cable with bracket (Audio8K)
- Optional USB cable with bracket (USB2K-4)
- Optional Secondary CRT VGA cable with bracket (VGA4K, for use with IBA110)
- Optional TMDS cable with bracket (ID120P, for use with IBA110)
- Optional TV-out cable (TVOUT-6, for use with IBA120)
- Optional MicroAGP cards (IBA120, IBA110)

Product Description

The IB840 Pentium 4 CPU card incorporates the Intel 865G chipset that can utilize a single PGA478 processor of up to 3.2GHz or higher and supports FSB frequency of 400/533/800Mhz (100Mhz, 133Mhz, and 200Mhz HCLK respectively).

The 865G chipset comes with a Graphics Memory Controller Hub (GMCH) designed for use with the Pentium 4 processor with 512-KB L2 cache on 0.13 micron process. The GMCH component provides the CPU interface, DDR interface, AGP interface, Hub Interface, and integrated graphics with display interfaces.

Aside from CRT support, the VGA function feature a Micro AGP slot for optional daughter cards:

- IBA120: with Chrontel CH7017 chipset that supports dual channel LVDS, TV-out interface

- IBA110: with ATI M7CSP32, M9CSP64 / M10CSP64 chipset, 64MB/32MB frame buffer and supports dual channel LVDS interface, TMDS and CRT2 display function.

The board also has one Intel 82547EI Gigabit LAN and an Intel 82551 10/100MB fast Ethernet LAN.

Other advanced features include two Serial ATA ports, four USB 2.0 ports, IrDA interface and audio function.

Specifications

Product Name	IB840
Form Factor	PICMG (full size CPU card)
CPU Type	Socket 478 (Intel Pentium 4)
CPU Voltage	0.8375V~1.6V (VRD 10)
System Speed	1.30G~3.2GHz
CPU Frequency	400 MHz /533MHz/800MHz
Green /APM	APM1.2
CPU Socket	Socket 478
Chipset	Intel 865G Chipset GMCH: 82865G 932 pin FC-BGA ICH5: 82801EB 460 pin MBGA
BIOS	Award BIOS, support ACPI Function
Cache	128K/256K/512K Level 2 (CPU integrated)
VGA	Two selections: 1. Embedded 82865G, AGP 4X, support CRT interface only. 2. On board ATI Mobility M7/ M9 / M10 graphics controller, embedded 32/64MB Frame buffer (DDR), AGP 4X, support CRT, LVDS, TV-out / 2nd CRT.
Primary LAN	Intel 82551QM LAN controller (10/100Mb)
Secondary LAN	Intel 82547EI (10/100/1000Mb) Gigabit LAN
Audio	ICH5 Built-in Sound controller + AC97 Codec ALC650, 2x6 12 pin header (Line-out, Line-in, MIC.). Supports 5.1 channels.
Memory type	2 x DDR 2.5V PC266/333/400 DDR SDRAM (without ECC Function) DIMM Module, Max. capacity - 2GB
LPC I/O	Winbond 83627HF: IrDax1 Parallel x1, COM1(RS-232),COM2(RS-232/RS422/RS485), FDC 2.88MB (3 Mode Support), Hardware monitoring
RTC/CMOS	ICH5 Built-in
Battery	Lithium Battery
PS2 KB/Mouse	Controller built in Winbond 83627HF
Local bus IDE	ICH5 built in, IDE1, IDE2 (Ultra DMA 33/66/100)
Serial ATA	2 ports
PCI to ISA Bridge	ITE 8888
ISA High drive	Supported by SN74ABT16245
USB	4 ports, USB 2.0
IrDA	Pin header
Disk On Chip	Supports up to 288MB capacity
Watchdog Timer	Yes (256 segments : 0,1,2,...255 sec/min)
Expansion slots	MicroAGP VGA socket for IBA120 and IBA110
D-type connector	PS/2 keyboard/mouse, VGA (CRT), RJ-45 x 2
Power Connector	ATX 12V
System Voltages	+5V, +12V, -12V, 5VSB
Board Size	122 x 338 mm
Other Features	Modem Wakeup, LAN Wakeup ,

Board Dimensions

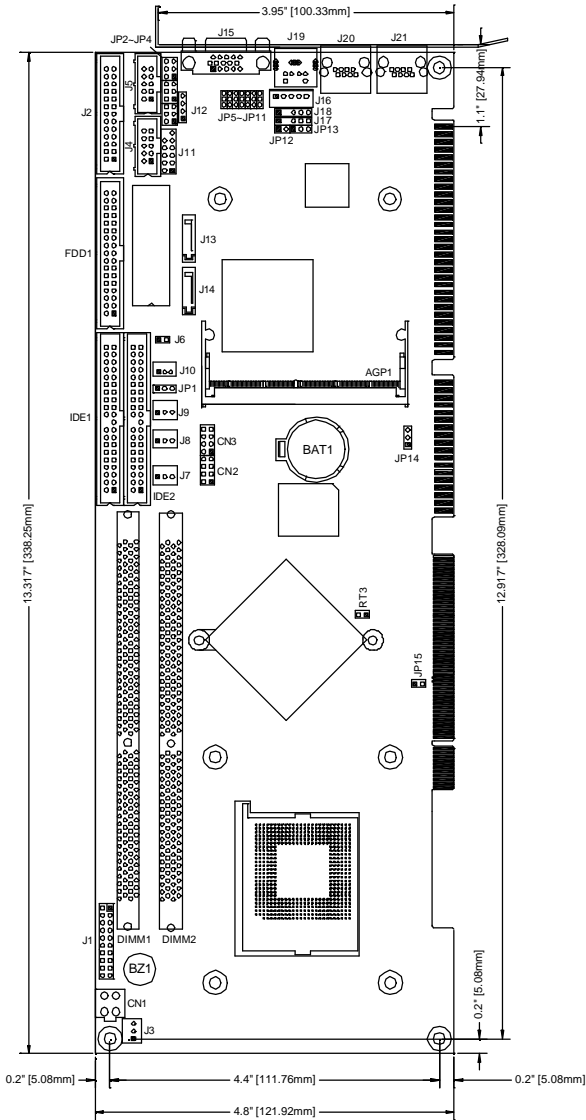

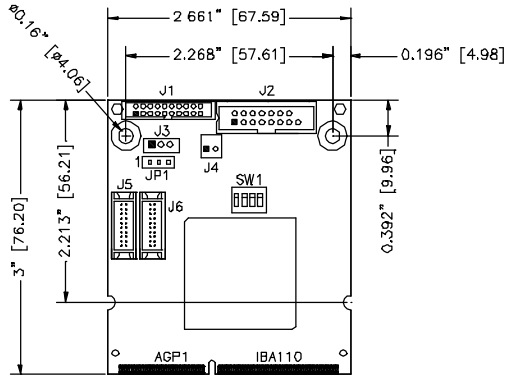
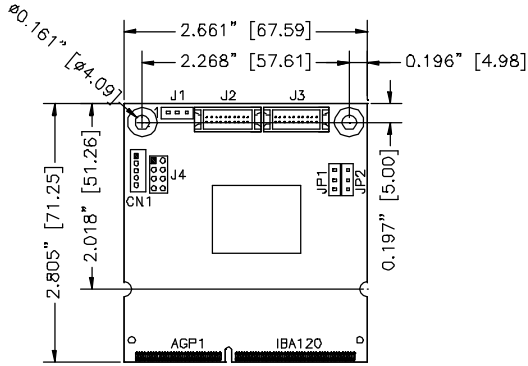

Installations

This section provides information on how to use the jumpers and connectors on the IB840 in order to set up a workable system. The topics covered are:

Installing the CPU.....	7
ATX Power Installation.....	8
Installing the Memory.....	8
Setting the Jumpers	9
Connectors on IB840.....	18

Installing the CPU

The IB840 CPU card supports a Socket 478 processor socket for Intel Pentium 4 processors.

The Socket 478 processor socket comes with a lever to secure the processor. Raise this lever to about a 90° angle to allow the insertion of the processor. Place the processor into the socket by making sure the notch on the corner of the CPU corresponds with the notch on the inside of the socket. Once the processor has slide into the socket, return the lever to the lock position. Refer to the figures below.

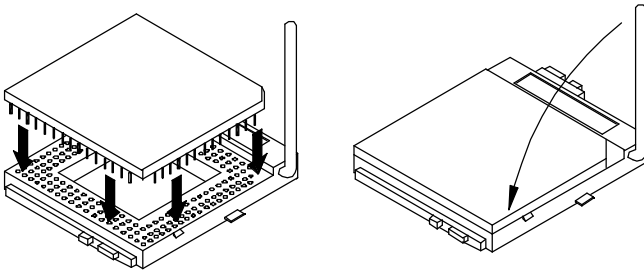

After you have installed the processor into the socket, check if the jumpers for the CPU type and speed are correct.

NOTE: *Ensure that the CPU heat sink and the CPU top surface are in total contact to avoid CPU overheating problem that would cause your system to hang or be unstable.*

ATX Power Installation

The system power is provided to the CPU card with the CN1 and J7 ATX power connectors. Please note that the J7 external ATX power connector should be connected to the backplane for IB840 to function. J7 is a 3-pin power connector. CN1 is a 4-pin 12V power connector. CN1 is to be connected to the ATX power supply.

Installing the Memory

The IB840 CPU card supports two DDR memory sockets for a maximum total memory of 2GB in DDR memory type. You can install unbuffered & non-ECC DDR DIMMs. It supports DDR266 when installed with CPUs that have clock speeds of 400MHz. It supports DDR266/333 when installed with CPUs that have clock speeds of 533MHz. It supports DDR266/320/400 when installed with CPUs that have clock speeds of 800MHz. The board provides dual channel functionality for its DIMM slots. DIMM1 for one channel and DIMM2 for the other channel. Enabling dual channels can increase data access rates.

Basically, the system memory interface has the following features:

- Supports two 64-bit wide DDR data channels
- Available bandwidth up to 3.2GB/s (DDR400) for single-channel mode and 6.4GB/s (DDR400) in dual-channel mode.
- Supports non ECC DIMMs.
- Supports 128Mb, 256Mb, 512Mb DDR technologies.
- Supports only x8, x16, DDR devices with four banks
- Registered DIMMs not supported
- Supports opportunistic refresh
- Up to 16 simultaneously open pages (four per row, four rows maximum)

Setting the Jumpers

Jumpers are used on IB840 to select various settings and features according to your needs and applications. Contact your supplier if you have doubts about the best configuration for your needs. The following lists the connectors on IB840 and their respective functions.

Jumper Locations on IB840.....	10
JP1: Clear CMOS Contents	11
JP2, JP3, JP4: RS232/422/485 (COM2) Selection	11
JP5/6/7/8/9/10/11: CRT VGA Signal Select.....	11
JP13: Primary LAN Enable/Disable.....	12
JP14: DiskOnChip Address Select.....	12
Jumper and Connectors on IBA120.....	13
J1: Panel Inverter Power Connector	13
JP2: Panel Voltage Setting.....	13
J4: TV out Connector.....	13
JP1: TV Type Select	14
JP2: LVDS Panel Power Select	14
J2, J3: LVDS Connectors (2nd channel, 1st channel).....	14
Jumper and Connectors on IBA110.....	15
J1: TMDS Panel Connector	15
J2: CRT2 / TV-Out Connector	15
J3: Panel Inverter Power Connector	16
J4: VGA Chipset Fan Power Connector	16
J5, J6: LVDS Connectors (2nd channel, 1st channel).....	16
JP1: LVDS Panel Power Select	16
SW1: LVDS Resolution Select.....	17

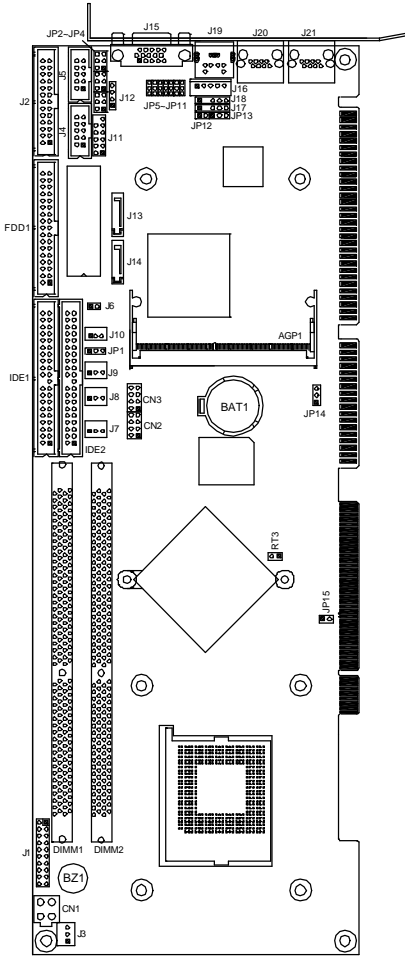

Jumper Locations on IB840



- JP1: Clear CMOS Contents
- JP2, JP3, JP4: RS232/422/485 (COM2) Selection
- JP5/6/7/8/9/10/11: CRT VGA Signal Select
- JP13: Primary LAN Enable/Disable
- JP14: DiskOnChip Address Select

JP1: Clear CMOS Contents

Use P8, a 3-pin header, to clear the CMOS contents. *Note that the ATX-power connector should be disconnected from the CPU card before clearing CMOS.*

JP1	Setting	Function
	Pin 1-2 Short/Closed	Normal
	Pin 2-3 Short/Closed	Clear CMOS

JP2, JP3, JP4: RS232/422/485 (COM2) Selection

J4, COM1 is fixed for RS-232 use only.

J5, COM2 is selectable for RS232, RS-422 and RS-485.

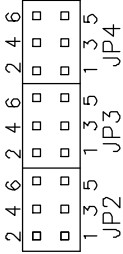

The following table describes the jumper settings for COM2 selection.

COM2 Function	RS-232	RS-422	RS-485
Jumper Setting (pin closed)	JP2: 1-2	JP2: 3-4	JP2: 5-6
	JP3: 3-5 & 4-6	JP3: 1-3 & 2-4	JP3: 1-3 & 2-4
	JP4: 3-5 & 4-6	JP4: 1-3 & 2-4	JP4: 1-3 & 2-4





JP5/6/7/8/9/10/11: CRT VGA Signal Select



Use these seven 3-pin headers to select the VGA signal either from the on board VGA or from the MicroAGP VGA.

JP5/6/7/8/9/10/11	Setting	Function
	Pin 1-2 Short/Closed	On board VGA
	Pin 2-3 Short/Closed	MicroAGP VGA

JP13: Primary LAN Enable/Disable

JP13	Function
	Enable LAN
	Disable LAN

JP14: DiskOnChip Address Select

JP14	Address
	D0000-D7FFF
	D8000-D9FFF (default)

Jumper and Connectors on IBA120

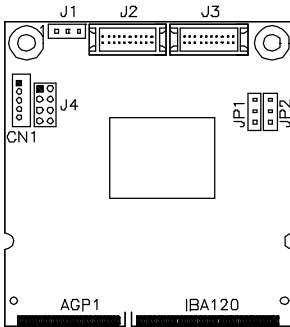

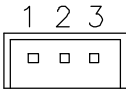

J1: Panel Inverter Power Connector



Pin #	Signal Name
1	+12V
2	ENABKL
3	Ground

Remarks: Maximum current is 1A.

JP2: Panel Voltage Setting

JP2	Setting	Panel Voltage
	Pin 1-2 Short/Closed	3.3V
	Pin 2-3 Short/Closed	5V

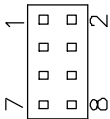

J4: TV out Connector

The pin assignments of the TV out connector are as follows:





Signal Name	Pin	Pin	Signal Name
Ground	1	2	Ground
Y	3	4	C
NC	5	6	NC
COMP	7	8	Protect pin

JP1: TV Type Select

JP1	Setting	TV Type
	Pin 1-2 Short/Closed	NTSC
	Pin 2-3 Short/Closed	PAL

JP2: LVDS Panel Power Select

JP2	Setting	Panel Voltage
	Pin 1-2 Short/Closed	3.3V (default)
	Pin 2-3 Short/Closed	5V

J2, J3: LVDS Connectors (2nd channel, 1st channel)

The LVDS connectors, DF13 20-pin mating connectors, are composed of the first channel (J2) and second channel (J3) to support 24-bit or 48-bit.

Signal Name	Pin #	Pin #	Signal Name
TX0-	2	1	TX0+
Ground	4	3	Ground
TX1-	6	5	TX1+
5V/3.3V	8	7	Ground
TX3-	10	9	TX3+
TX2-	12	11	TX2+
Ground	14	13	Ground
TXC-	16	15	TXC+
5V/3.3V	18	17	ENABKL
+12V	20	19	+12V

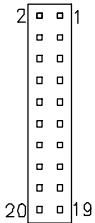

Remarks: Maximum current for +12V is 1A.

Jumper and Connectors on IBA110

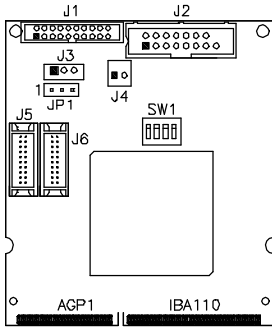

J1: TMDS Panel Connector

TMDS stands Transition Minimized Differential Signaling.

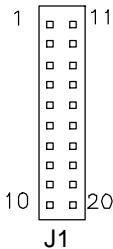

Signal Name	Pin #	Pin #	Signal Name
TX1P	1	11	TX2P
TXIN	2	12	TX2N
GND	3	13	GND
GND	4	14	GND
TXCP	5	15	TX0P
TXCN	6	16	TX0N
GND	7	17	NC
+5v	8	18	NC
HTPG	9	19	DDCDATA
NC	10	20	DDCCLK

J2: CRT2 / TV-Out Connector

This connector is used for a second CRT monitor or use with a TV output device.

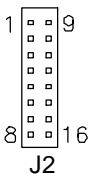

Signal Name	Pin #	Pin #	Signal Name
Red / C	1	9	+5V
Green / Y	2	10	Ground
Blue / COMP	3	11	N. C.
N.C.	4	12	CRT2 DDCCDAT
Ground	5	13	HSYNC
Ground	6	14	VSYNC
Ground	7	15	CRT2 DDCCCLK
Ground	8	16	N.C.

J3: Panel Inverter Power Connector

The connector supports 1A current (maximum).

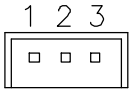

Pin #	Signal Name
1	+12V
2	NC
3	Ground

J4: VGA Chipset Fan Power Connector



Pin #	Signal Name
1	+12V
2	Ground

J5, J6: LVDS Connectors (2nd channel, 1st channel)

The LVDS connectors, DF13 20-pin mating connectors, are composed of the first channel (J6) and second channel (J5) to support 24-bit or 48-bit.

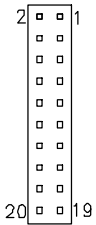

Signal Name	Pin #	Pin #	Signal Name
TX0-	2	1	TX0+
Ground	4	3	Ground
TX1-	6	5	TX1+
5V/3.3V	8	7	Ground
TX3-	10	9	TX3+
TX2-	12	11	TX2+
Ground	14	13	Ground
TXC-	16	15	TXC+
5V/3.3V	18	17	ENABKL
+12V	20	19	+12V

Remarks: Maximum current for +12V is 1A.

JP1: LVDS Panel Power Select

JP1	Setting	Panel Voltage
<p>A diagram of a 3-pin connector with pins 1, 2, and 3. A line connects pin 1 and pin 2, indicating they are shorted.</p>	Pin 1-2 Short/Closed	3.3V (default)
<p>A diagram of a 3-pin connector with pins 1, 2, and 3. A line connects pin 2 and pin 3, indicating they are shorted.</p>	Pin 2-3 Short/Closed	5V

SW1: LVDS Resolution Select

SW1-1	SW1-2	SW1-3	Resolution
OFF	ON	ON	800x600 18 bit
ON	OFF	ON	1024x768 18bit
OFF	OFF	ON	1024x768 24 bit

Connectors on IB840

The connectors on IB840 allows you to connect external devices such as keyboard, floppy disk drives, hard disk drives, printers, etc. The following table lists the connectors on IB840 and their respective functions.

Connector Locations on IB840.....	19
IDE1, IDE2: EIDE Connectors.....	19
FDD1: Floppy Drive Connector.....	21
CN1: ATX 12V/+12V Power Connector.....	21
CN2, CN3: USB Connectors.....	21
J3: CPU Fan Power Connector.....	22
J7: External ATX Power Connector.....	22
J8, J9: System Fan Power Connector.....	22
J1: System Function Connector.....	23
J2: Parallel Port Connector.....	25
J4, J5: COM1 and COM2 Serial Ports Connector.....	25
J10: Wake On LAN Connector.....	26
J11: External Audio Connector.....	26
J12: CD-In Audio Connector.....	26
J13, J14: Serial ATA (SATA) Connectors.....	26
J15: VGA CRT Connector.....	27
J16, J18: External PS/2 Mouse and Keyboard Connector.....	27
J17: IrDA Connector.....	27
J19: PS/2 Keyboard and Mouse Connector.....	28
J20: Primary RJ45 Connector.....	28
J21: Gigabit LAN RJ45 Connector.....	28
AGP1: MicroAGP Connector (for IBA110 / IBA120).....	28

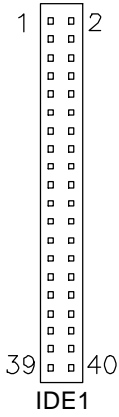

Signal Name	Pin #	Pin #	Signal Name
Reset IDE	1	2	Ground
Host data 7	3	4	Host data 8
Host data 6	5	6	Host data 9
Host data 5	7	8	Host data 10
Host data 4	9	10	Host data 11
Host data 3	11	12	Host data 12
Host data 2	13	14	Host data 13
Host data 1	15	16	Host data 14
Host data 0	17	18	Host data 15
Ground	19	20	Protect pin
DRQ0	21	22	Ground
Host IOW	23	24	Ground
Host IOR	25	26	Ground
IOCHRDY	27	28	Host ALE
DACK0	29	30	Ground
IRQ14	31	32	No connect
Address 1	33	34	No connect
Address 0	35	36	Address 2
Chip select 0	37	38	Chip select 1
Activity	39	40	Ground

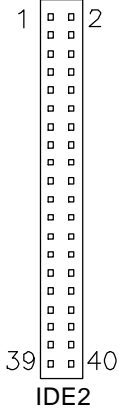

Signal Name	Pin #	Pin #	Signal Name
Reset IDE	1	2	Ground
Host data 7	3	4	Host data 8
Host data 6	5	6	Host data 9
Host data 5	7	8	Host data 10
Host data 4	9	10	Host data 11
Host data 3	11	12	Host data 12
Host data 2	13	14	Host data 13
Host data 1	15	16	Host data 14
Host data 0	17	18	Host data 15
Ground	19	20	Protect pin
DRQ1	21	22	Ground
Host IOW	23	24	Ground
Host IOR	25	26	Ground
IOCHRDY	27	28	Host ALE
DACK1	29	30	Ground
IRQ15	31	32	No connect
Address 1	33	34	No connect
Address 0	35	36	Address 2
Chip select 0	37	38	Chip select 1
Activity	39	40	Ground

FDD1: Floppy Drive Connector

FDD1 is a 34-pin header and will support up to 2.88MB floppy drives.

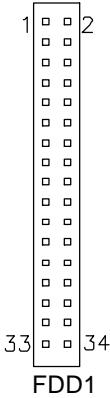

Signal Name	Pin #	Pin #	Signal Name
Ground	1	2	RM/LC
Ground	3	4	No connect
Ground	5	6	No connect
Ground	7	8	Index
Ground	9	10	Motor enable 0
Ground	11	12	Drive select 1
Ground	13	14	Drive select 0
Ground	15	16	Motor enable 1
Ground	17	18	Direction
Ground	19	20	Step
Ground	21	22	Write data
Ground	23	24	Write gate
Ground	25	26	Track 00
Ground	27	28	Write protect
Ground	29	30	Read data
Ground	31	32	Side 1 select
Ground	33	34	Diskette change

CN1: ATX 12V/+12V Power Connector

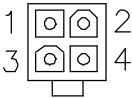

Pin #	Signal Name
1	Ground
2	Ground
3	+12V
4	+12V

CN2, CN3: USB Connectors

The following table shows the pin outs of the USB pin headers connectors. Overall, the two pin headers support four USB ports.

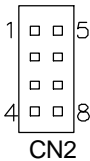

Signal Name	Pin	Pin	Signal Name
Vcc	1	5	Ground
USB0-	2	6	USB1+
USB0+	3	7	USB1-
Ground	4	8	Vcc

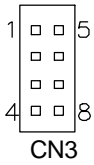

Signal Name	Pin	Pin	Signal Name
Vcc	1	5	Ground
USB2-	2	6	USB3+
USB2+	3	7	USB3-
Ground	4	8	Vcc

J3: CPU Fan Power Connector

J3 is a 3-pin header for the CPU fan. The fan must be a 12V fan.

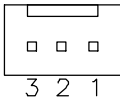

Pin #	Signal Name
1	Ground
2	+12V
3	Rotation detection

J7: External ATX Power Connector

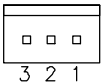

Pin #	Signal Name
1	Ground
2	PS-ON (soft on/off)
3	5VSB (Standby +5V)

J8, J9: System Fan Power Connector

J8 and J9 are 3-pin headers for system fans. The fan must be a 12V fan.

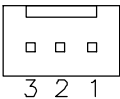

Pin #	Signal Name
1	Ground
2	+12V
3	Rotation detection

J1: System Function Connector

J1 provides connectors for system indicators that provide light indication of the computer activities and switches to change the computer status. J1 is a 20-pin header that provides interfaces for the following functions.

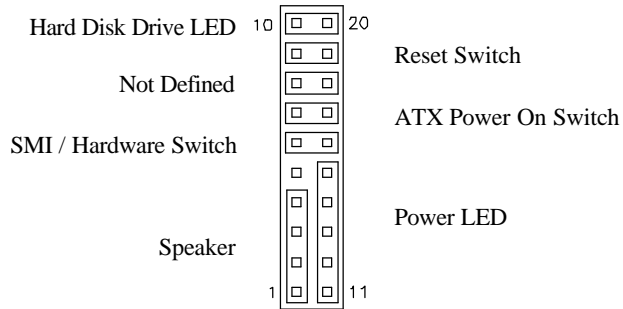

Speaker: Pins 1 - 4

This connector provides an interface to a speaker for audio tone generation. An 8-ohm speaker is recommended.

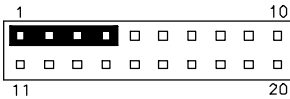

Pin #	Signal Name
1	Speaker out
2	No connect
3	Ground
4	+5V

Power LED: Pins 11 - 15

The power LED indicates the status of the main power switch.

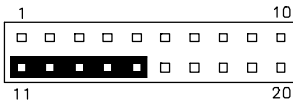

Pin #	Signal Name
11	Power LED
12	No connect
13	Ground
14	No connect
15	Ground

SMI/Hardware Switch: Pins 6 and 16

This connector supports the "Green Switch" on the control panel, which, when pressed, will force the system into the power-saving mode immediately.

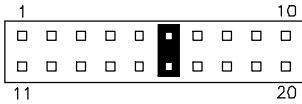

Pin #	Signal Name
6	SMI
16	Ground

ATX Power ON Switch: Pins 7 and 17

This 2-pin connector is an "ATX Power Supply On/Off Switch" on the system that connects to the power switch on the case. When pressed, the power switch will force the system to power on. When pressed again, it will force the system to power off.

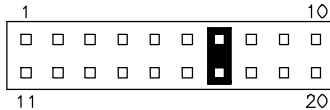

Reset Switch: Pins 9 and 19

The reset switch allows the user to reset the system without turning the main power switch off and then on again. Orientation is not required when making a connection to this header.

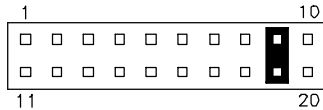

Hard Disk Drive LED Connector: Pins 10 and 20

This connector connects to the hard drive activity LED on control panel. This LED will flash when the HDD is being accessed.

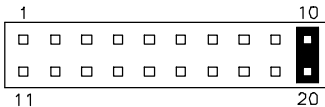

Pin #	Signal Name
10	HDD Active
20	5V

J2: Parallel Port Connector

The following table describes the pin out assignments of this connector.

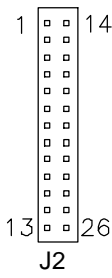

Signal Name	Pin #	Pin #	Signal Name
Line printer strobe	1	14	AutoFeed
PD0, parallel data 0	2	15	Error
PD1, parallel data 1	3	16	Initialize
PD2, parallel data 2	4	17	Select
PD3, parallel data 3	5	18	Ground
PD4, parallel data 4	6	19	Ground
PD5, parallel data 5	7	20	Ground
PD6, parallel data 6	8	21	Ground
PD7, parallel data 7	9	22	Ground
ACK, acknowledge	10	23	Ground
Busy	11	24	Ground
Paper empty	12	25	Ground
Select	13	N/A	N/A

J4, J5: COM1 and COM2 Serial Ports Connector

J4 and J5 both 10-pin headers, are the onboard serial port connectors.

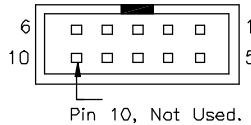

J4
Fixed as
RS-232

J5
Configurable
as RS-232/
RS-422/485
with jumpers
JP2/JP3/JP4

Pin #	Signal Name		
	RS-232	RS-422	RS-485
1	DCD	TX-	DATA-
2	RX	TX+	DATA+
3	TX	RX+	NC
4	DTR	RX-	NC
5	GND	GND	GND
6	DSR	RTS-	NC
7	RTS	RTS+	NC
8	CTS	CTS+	NC
9	RI	CTS-	NC
10	NC	NC	NC

J10: Wake On LAN Connector

J10 is a 3-pin header for the Wake On LAN function on the motherboard. The following table shows the pin out assignments of this connector. Wake On LAN will function properly only with an ATX power supply with 5VSB that has 1A.

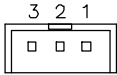

Pin #	Signal Name
1	+5VSB
2	Ground
3	LAN Wakeup

J11: External Audio Connector

J11 is a 12-pin header that is used to connect to the optional audio cable that integrates jacks for Line In, Line Out and Mic.

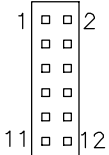

Signal Name	Pin #	Pin #	Signal Name
LINEOUT_R	1	2	LINEOUT_L
Ground	3	4	Ground
LINEIN_R	5	6	LINEIN_L
Ground	7	8	Ground
Mic-In	9	10	VREFOUT
Ground	11	12	Protect pin

J12: CD-In Audio Connector

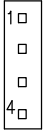

Pin #	Signal Name
1	CD Audio R
2	Ground
3	Ground
4	CD Audio L

J13, J14: Serial ATA (SATA) Connectors

The SATA connectors support serial ATA 150. Each connector can only use one serial ATA hard disk. J13 is port 1 and J14 is port 2.

J15: VGA CRT Connector

The pin assignments of the J15 VGA CRT connector are as follows:

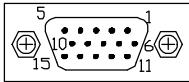

J15

Signal Name	Pin	Pin	Signal Name
Red	1	2	Green
Blue	3	4	N.C.
GND	5	6	GND
GND	7	8	GND
N.C.	9	10	GND
N.C.	11	12	N.C.
HSYNC	13	14	VSYNC
NC	15		

J16, J18: External PS/2 Mouse and Keyboard Connector

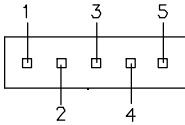

Pin #	J16	J18
1	KB clock	Mouse data
2	KB data	N.C.
3	N.C.	Ground
4	Ground	Vcc
5	Vcc	Mouse clock

J17: IrDA Connector

J17 is used for an optional IrDA connector for wireless communication.

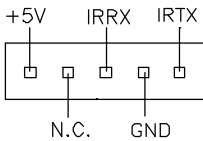

Pin #	Signal Name
1	+5V
2	No connect
3	Ir RX
4	Ground
5	Ir TX

J19: PS/2 Keyboard and Mouse Connector

J19 uses a Y-cable with dual D-connectors for a PS/2 keyboard and a PS/2 mouse.

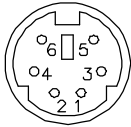

J19

Pin #	Signal Name
1	Mouse data
2	Keyboard data
3	Ground
4	Vcc
5	Mouse Clock
6	Keyboard Clock

J20: Primary RJ45 Connector

J20 is the primary RJ-45 connector based on the chipset integrated LAN. The figure below shows the pin out assignments of the connector and its corresponding input jack.

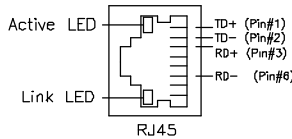

J21: Gigabit LAN RJ45 Connector

J21 is the Gigabit LAN RJ45 connector.

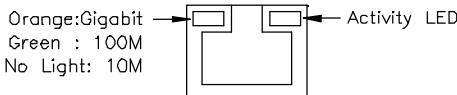

AGP1: MicroAGP Connector (for IBA110 / IBA120)

BIOS Setup

This chapter describes the different settings available in the Award BIOS that comes with the CPU card. The topics covered in this chapter are as follows:

BIOS Introduction	30
BIOS Setup.....	30
Standard CMOS Setup.....	32
Advanced BIOS Features	35
Advanced Chipset Features	38
Integrated Peripherals.....	41
Power Management Setup.....	45
PNP/PCI Configurations	48
PC Health Status	49
Frequency/Voltage Control.....	50
Load Fail-Safe Defaults	51
Load Setup Defaults	51
Set Supervisor/User Password.....	51
Save & Exit Setup	51
Exit Without Saving.....	51

BIOS Introduction

The Award BIOS (Basic Input/Output System) installed in your computer system's ROM supports Intel Pentium 4 processors. The BIOS provides critical low-level support for a standard device such as disk drives, serial ports and parallel ports. It also adds virus and password protection as well as special support for detailed fine-tuning of the chipset controlling the entire system.

BIOS Setup

The Award BIOS provides a Setup utility program for specifying the system configurations and settings. The BIOS ROM of the system stores the Setup utility. When you turn on the computer, the Award BIOS is immediately activated. Pressing the key immediately allows you to enter the Setup utility. If you are a little bit late pressing the key, POST (Power On Self Test) will continue with its test routines, thus preventing you from invoking the Setup. If you still wish to enter Setup, restart the system by pressing the "Reset" button or simultaneously pressing the <Ctrl>, <Alt> and <Delete> keys. You can also restart by turning the system Off and back On again. The following message will appear on the screen:

```
Press <DEL> to Enter Setup
```

In general, you press the arrow keys to highlight items, <Enter> to select, the <PgUp> and <PgDn> keys to change entries, <F1> for help and <Esc> to quit.

When you enter the Setup utility, the Main Menu screen will appear on the screen. The Main Menu allows you to select from various setup functions and exit choices.

Phoenix - AwardBIOS CMOS Setup Utility

Standard CMOS Features	Frequency/Voltage Control
Advanced BIOS Features	Load Fail-Safe Defaults
Advanced Chipset Features	Load Optimized Defaults
Integrated Peripherals	Set Supervisor Password
Power Management Setup	Set User Password
PnP/PCI Configurations	Save & Exit Setup
PC Health Status	Exit Without Saving
ESC : Quit	↑ ↓ → ← : Select Item
F10 : Save & Exit Setup	
Time, Date, Hard Disk Type...	

The section below the setup items of the Main Menu displays the control keys for this menu. At the bottom of the Main Menu just below the control keys section, there is another section, which displays information on the currently highlighted item in the list.

Note: *If the system cannot boot after making and saving system changes with Setup, the Award BIOS supports an override to the CMOS settings that resets your system to its default.*

Warning: *It is strongly recommended that you avoid making any changes to the chipset defaults. These defaults have been carefully chosen by both Award and your system manufacturer to provide the absolute maximum performance and reliability. Changing the defaults could cause the system to become unstable and crash in some cases.*

Standard CMOS Setup

“Standard CMOS Setup” choice allows you to record some basic hardware configurations in your computer system and set the system clock and error handling. If the CPU card is already installed in a working system, you will not need to select this option. You will need to run the Standard CMOS option, however, if you change your system hardware configurations, the onboard battery fails, or the configuration stored in the CMOS memory was lost or damaged.

Phoenix - AwardBIOS CMOS Setup Utility
Standard CMOS Features

		Item Help
Date (mm:dd:yy)	Thu, May 21, 2001	Menu Level Change the day, month, Year and century
Time (hh:mm:ss)	00 : 00 : 00	
IDE Channel 0 Master	Press Enter 13020 MB	
IDE Channel 0 Slave	Press Enter None	
IDE Channel 1 Master	Press Enter None	
IDE Channel 1 Slave	Press Enter None	
IDE Channel 2 Master		
IDE Channel 3 Master		
Drive A	1.44M, 3.5 in.	
Drive B	None	
Video	EGA/VGA	
Halt On	All Errors	
Base Memory	640K	
Extended Memory	129024K	
Total Memory	130048K	

At the bottom of the menu are the control keys for use on this menu. If you need any help in each item field, you can press the <F1> key. It will display the relevant information to help you. The memory display at the lower right-hand side of the menu is read-only. It will adjust automatically according to the memory changed. The following describes each item of this menu.

Date

The date format is:

Day : Sun to Sat
Month : 1 to 12
Date : 1 to 31
Year : 1994 to 2079

To set the date, highlight the “Date” field and use the PageUp/ PageDown or +/- keys to set the current time.

Time

The time format is: **Hour : 00 to 23**
Minute : 00 to 59
Second : 00 to 59

To set the time, highlight the “Time” field and use the <PgUp>/ <PgDn> or +/- keys to set the current time.

IDE Primary HDDs / IDE Secondary HDDs

The onboard PCI IDE connectors provide Primary and Secondary channels for connecting up to four IDE hard disks or other IDE devices. Each channel can support up to two hard disks; the first is the “Master” and the second is the “Slave”.

Press <Enter> to configure the hard disk. The selections include Auto, Manual, and None. Select ‘Manual’ to define the drive information manually. You will be asked to enter the following items.

CYLS : Number of cylinders
HEAD : Number of read/write heads
PRECOMP : Write precompensation
LANDZ : Landing zone
SECTOR : Number of sectors

The Access Mode selections are as follows:

Auto
Normal (HD < 528MB)
Large (for MS-DOS only)
LBA (HD > 528MB and supports
Logical Block Addressing)

Remarks: The main board supports two serial ATA ports and are represented in this setting as IDE Channel 2 / 3 Master.

Drive A / Drive B

These fields identify the types of floppy disk drive A or drive B that has been installed in the computer. The available specifications are:

360KB	1.2MB	720KB	1.44MB	2.88MB
5.25 in.	5.25 in.	3.5 in.	3.5 in.	3.5 in.

Video

This field selects the type of video display card installed in your system. You can choose the following video display cards:

EGA/VGA	For EGA, VGA, SEGA, SVGA or PGA monitor adapters. (default)
CGA 40	Power up in 40 column mode.
CGA 80	Power up in 80 column mode.
MONO	For Hercules or MDA adapters.

Halt On

This field determines whether or not the system will halt if an error is detected during power up.

No errors	The system boot will not be halted for any error that may be detected.
All errors	Whenever the BIOS detects a non-fatal error, the system will stop and you will be prompted.
All, But Keyboard	The system boot will not be halted for a keyboard error; it will stop for all other errors
All, But Diskette	The system boot will not be halted for a disk error; it will stop for all other errors.
All, But Disk/Key	The system boot will not be halted for a keyboard or disk error; it will stop for all others.

Advanced BIOS Features

This section allows you to configure and improve your system and allows you to set up some system features according to your preference.

Phoenix - AwardBIOS CMOS Setup Utility
Advanced BIOS Features

		ITEM HELP
Hard Disk Boot Priority	Press Enter	Menu Level Allows you choose the VIRUS warning feature for IDE Hard Disk boot sector protection. If this function is enabled and someone attempt to write data into this area, BIOS will show a warning message on screen and alarm beep
CD-ROM Boot Priority	Press Enter	
CPU L1 and L2 Cache	Enabled	
Quick Power On Self Test	Enabled	
First Boot Device	Floppy	
Second Boot Device	Hard Disk	
Third Boot Device	CD-ROM	
Boot Other Device	Enabled	
Swap Floppy Drive	Disabled	
Boot Up Floppy Seek	Disabled	
Boot Up Numlock Status	On	
Gate A20 Option	Fast	
Typematic Rate Setting	Disabled	
Typematic Rate (chars/Sec)	6	
Typematic Delay (Msec)	250	
Security Option	Setup	
APIC Mode	Enabled	
MPS Version Control for OS	1.4	
OS Select For DRAM>64MB	Non-OS2	
Report No FDD For WIN 95	Yes	
Small Logo (EPA) Show	Enable	

Hard Disk / CD-ROM Boot Priority

This item allows you to set the priority for hard disk boot. When you press enter, the selections shows the current hard disks used in your system as well as the "Bootable Add-in Card" that is relevant to other boot sources media such as SCSI cards and LAN cards.

CPU L1 and L2 Cache

Cache memory is additional memory that is much faster than conventional DRAM (system memory). CPUs from 486-type on up contain internal cache memory, and most, but not all, modern PCs have additional (external) cache memory. When the CPU requests data, the system transfers the requested data from the main DRAM into cache memory, for even faster access by the CPU. These items allow you to enable (speed up memory access) or disable the cache function. By default, these items are Enabled.

Quick Power On Self Test

When enabled, this field speeds up the Power On Self Test (POST) after the system is turned on. If it is set to *Enabled*, BIOS will skip some items.

First/Second/Third Boot Device

These fields determine the drive that the system searches first for an operating system. The options available include *Floppy*, *LS/ZIP*, *HDD-0*, *SCSI*, *CDROM*, *HDD-1*, *HDD-2*, *HDD-3*, *LAN* and *Disable*.

Boot Other Device

These fields allow the system to search for an operating system from other devices other than the ones selected in the First/Second/Third Boot Device.

Swap Floppy Drive

This item allows you to determine whether or not to enable Swap Floppy Drive. When enabled, the BIOS swaps floppy drive assignments so that Drive A becomes Drive B, and Drive B becomes Drive A. By default, this field is set to *Disabled*.

Boot Up Floppy Seek

This feature controls whether the BIOS checks for a floppy drive while booting up. If it cannot detect one (either due to improper configuration or its absence), it will flash an error message.

Boot Up NumLock Status

This allows you to activate the NumLock function after you power up the system.

Gate A20 Option

This field allows you to select how Gate A20 is worked. Gate A20 is a device used to address memory above 1 MB.

Typematic Rate Setting

When disabled, continually holding down a key on your keyboard will generate only one instance. When enabled, you can set the two typematic controls listed next. By default, this field is set to *Disabled*.

Typematic Rate (Chars/Sec)

When the typematic rate is enabled, the system registers repeated keystrokes speeds. Settings are from 6 to 30 characters per second.

Typematic Delay (Msec)

When the typematic rate is enabled, this item allows you to set the time interval for displaying the first and second characters. By default, this item is set to *250msec*.

Security Option

This field allows you to limit access to the System and Setup. The default value is *Setup*. When you select *System*, the system prompts for the User Password every time you boot up. When you select *Setup*, the system always boots up and prompts for the Supervisor Password only when the Setup utility is called up.

APIC Mode

APIC stands for Advanced Programmable Interrupt Controller. The default setting is *Enabled*.

MPS Version Control for OS

This option specifies the MPS (Multiprocessor Specification) version for your operating system. MPS version 1.4 added extended configuration tables to improve support for multiple PCI bus configurations and improve future expandability. The default setting is *1.4*.

OS Select for DRAM > 64MB

This option allows the system to access greater than 64MB of DRAM memory when used with OS/2 that depends on certain BIOS calls to access memory. The default setting is *Non-OS/2*.

Report No FDD For WIN 95

If you are using Windows 95/98 without a floppy disk drive, select Enabled to release IRQ6. This is required to pass Windows 95/98's SCT test. You should also disable the Onboard FDC Controller in the Integrated Peripherals screen when there's no floppy drive in the system. If you set this feature to Disabled, the BIOS will not report the missing floppy drive to Win95/98.

Small Logo (EPA) Show

The EPA logo appears at the right side of the monitor screen when the system is boot up. The default setting is *Enabled*.

Advanced Chipset Features

This Setup menu controls the configuration of the chipset.

Phoenix - AwardBIOS CMOS Setup Utility
Advanced Chipset Features

		ITEM HELP
DRAM Timing Selectable	By SPD	Menu Level
CAS Latency Time	2.5	
Active to Precharge Delay	6	
DRAM RAS# to CAS# Delay	3	
DRAM RAS# Precharge	3	
Memory Frequency For	Auto	
System BIOS Cacheable	Enabled	
Video BIOS Cacheable	Disabled	
Memory Hole at 15M-16M	Disabled	
Delay Prior to Thermal	16 Min	
AGP Aperture Size (MB)	128	
Init Display First	PCI Slot	
** On-Chip VGA Setting **		
On-Chip VGA	Enabled	
On-Chip Frame Buffer Size	8MB	
Boot Display	CRT + LVDS	
Panel Scaling	Auto	
Panel Number	800x600 LVDS	
TV Standard	Off	
Video Connector	Automatic	
TV Format	Auto	

DRAM Timing Selectable

This option refers to the method by which the DRAM timing is selected. The default is **By SPD**.

CAS Latency Time

You can select CAS latency time in HCLKs of 2/2 or 3/3. The system board designer should set the values in this field, depending on the DRAM installed. Do not change the values in this field unless you change specifications of the installed DRAM or the installed CPU. The choices are 2 and 3.

Active to Precharge Delay

The default setting for the Active to Precharge Delay is **6**.

DRAM RAS# to CAS# Delay

This option allows you to insert a delay between the RAS (Row Address Strobe) and CAS (Column Address Strobe) signals. This delay occurs when the SDRAM is written to, read from or refreshed. Reducing the delay improves the performance of the SDRAM.

DRAM RAS# Precharge

This option sets the number of cycles required for the RAS to accumulate its charge before the SDRAM refreshes. The default setting for the Active to Precharge Delay is **3**.

Memory Frequency For

This field sets the frequency of the DRAM memory installed. The default setting is *Auto*. The other settings are *PC200* and *PC266*.

System BIOS Cacheable

The setting of *Enabled* allows caching of the system BIOS ROM at F000h-FFFFh, resulting in better system performance. However, if any program writes to this memory area, a system error may result.

Video BIOS Cacheable

The Setting *Enabled* allows caching of the video BIOS ROM at C0000h-F7FFFh, resulting in better video performance. However, if any program writes to this memory area, a system error may result.

Memory Hole At 15M-16M

In order to improve performance, certain space in memory can be reserved for ISA cards. This memory must be mapped into the memory space below 16 MB. The choices are *Enabled* and *Disabled*.

Delay Prior to Thermal

This field activates the CPU thermal function after the systems boots for the set number of minutes. The options are *16Min* and *64Min*.

AGP Aperture Size

The field sets aperture size of the graphics. The aperture is a portion of the PCI memory address range dedicated for graphics memory address space. Host cycles that hit the aperture range are forwarded to the AGP without any translation. The default setting is *128M*.

Init Display First

This field allows the system to initialize first the VGA on chip or the display card on the PCI Slot.

On-Chip VGA

By default, the On-Chip VGA or 865G chipset-integrated VGA is *Enabled*.

On-Chip Frame Buffer Size

The On-Chip Frame Buffer Size can be set us 1MB, 8MB or 16MB. This memory is shared with the system memory.

Boot Display

Boot Display determines the display output device where the system boots. The default setting is *LVDS*.

Panel Scaling

With the default setting of Auto, this item automatically displays the resolution of the panel used in the system to 'full' screen.

Panel Number

By default, this item is set to *800 x 600 LVDS*. If you are using other kinds of panel, enter this field to select the one that suits your panel.

TV Standard

By default, this item is set to *off*.

Video Connector

By default, this item is set to *Automatic*.

TV Format

By default, this item is set to *Auto*.

Integrated Peripherals

This section sets configurations for your hard disk and other integrated peripherals. The first screen shows three main items for user to select. Once an item selected, a submenu appears. Details follow.

Phoenix - AwardBIOS CMOS Setup Utility
Integrated Peripherals

On-Chip Primary IDE Device	Press Enter	ITEM HELP
Onboard Device	Press Enter	Menu Level
SuperIO Device	Press Enter	

Phoenix - AwardBIOS CMOS Setup Utility
OnChip IDE Device

IDE Block Mode	Enabled	ITEM HELP
On-Chip Primary PCI IDE	Enabled	Menu Level
IDE Primary Master PIO	Auto	
IDE Primary Slave PIO	Auto	
IDE Primary Master UDMA	Auto	
IDE Primary Slave UDMA	Auto	
On-Chip Secondary PCI IDE	Enabled	
IDE Secondary Master PIO	Auto	
IDE Secondary Slave PIO	Auto	
IDE Secondary Master UDMA	Auto	
IDE Secondary Slave UDMA	Auto	
*** On-Chip Serial ATA Setting ***		
On-Chip Serial ATA	Auto	
Serial ATA Port0 Mode	SATA0 master	
Serial ATA Port1 Mode	SATA1 master	

Phoenix - AwardBIOS CMOS Setup Utility
Onboard Device

USB 2.0 Controller	Enabled	ITEM HELP
USB Controller	Disabled	Menu Level
USB Keyboard Support	Disabled	
USB Mouse Support	Disabled	
AC97 Audio	Auto	
CSA LAN (Giga-LAN)	Enable	

Phoenix - AwardBIOS CMOS Setup Utility
SuperIO Device

Onboard FDC Controller	Enabled	ITEM HELP
Onboard Serial Port 1	3F8/IRQ4	Menu Level
Onboard Serial Port 2	2F8/IRQ3	
UART Mode Select	Normal	
Onboard Parallel Port	378/IRQ7	
Parallel Port Mode	SPP	

IDE HDD Block Mode

This field allows your hard disk controller to use the fast block mode to transfer data to and from your hard disk drive.

OnChip Primary/Secondary PCI IDE

The integrated peripheral controller contains an IDE interface with support for two IDE channels. Select *Enabled* to activate each channel separately.

IDE Primary/Secondary Master/Slave PIO

These fields allow your system hard disk controller to work faster. Rather than have the BIOS issue a series of commands that transfer to or from the disk drive, PIO (Programmed Input/Output) allows the BIOS to communicate with the controller and CPU directly.

The system supports five modes, numbered from 0 (default) to 4, which primarily differ in timing. When Auto is selected, the BIOS will select the best available mode.

IDE Primary/Secondary Master/Slave UDMA

These fields allow your system to improve disk I/O throughput to 33Mb/sec with the Ultra DMA/33 feature. The options are *Auto* and *Disabled*.

On-Chip Serial ATA

The default setting of *Auto* allows the Serial ATA drive to be enabled, when the system detects one.

USB Controller

The options for this field are *Enabled* and *Disabled*. By default, this field is set to *Enabled*.

USB 2.0 Controller

The options for this field are *Enabled* and *Disabled*. By default, this field is set to *Disabled*. In order to use USB 2.0, necessary OS drivers must be installed first.

USB Keyboard Support

The options for this field are *Enabled* and *Disabled*. By default, this field is set to *Disabled*.

USB Mouse Support

The options for this field are *Enabled* and *Disabled*. By default, this field is set to *Disabled*.

AC97 Audio

The default setting of the AC97 Audio is *Auto*.

CSA LAN (Giga-LAN)

The default setting of the onboard Gigabit LAN is enabled.

Onboard FDC Controller

Select *Enabled* if your system has a floppy disk controller (FDC) installed on the CPU card and you wish to use it. If you install an add-in FDC or the system has no floppy drive, select *Disabled* in this field. This option allows you to select the onboard FDD port.

Onboard Serial/Parallel Port

These fields allow you to select the onboard serial and parallel ports and their addresses. The default values for these ports are:

Serial Port 1	3F8/IRQ4
Serial Port 2	2F8/IRQ3
Parallel Port	378H/IRQ7

UART Mode Select

This field determines the UART 2 mode in your computer. The default value is *Normal*. Other options include *IrDA* and *ASKIR*.

Parallel Port Mode

This field allows you to determine parallel port mode function.

- | | |
|-----|----------------------------|
| SPP | Standard Printer Port |
| EPP | Enhanced Parallel Port |
| ECP | Extended Capabilities Port |

Power Management Setup

The Power Management Setup allows you to save energy of your system effectively.

Phoenix - AwardBIOS CMOS Setup Utility
Power Management Setup

		ITEM HELP
Power-Supply Type	ATX	
ACPI Function	Enabled	Menu Level
ACPI Suspend Type	SI (POS)	Menu Level
Power Management	User Define	
Video Off Method	V/H SYNC+Blank	
Video Off In Suspend	Yes	
Suspend Type	Stop Grant	
Modem Use IRQ	3	
Suspend Mode	Disabled	
HDD Power Down	Disabled	
Soft-Off by PWR-BTTN	Instant-Off	
CPU THRM-Throttling	50%	
Wake-Up by PCI Card	Disabled	
Power On by Ring	Disabled	
Wake Up on CSA Lan	Disabled	
Resume by Alarm	Disabled	
Date (of Month) Alarm	0	
Time (hh:mm:ss) Alarm	0 : 0 : 0	
** Reload Global Timer Events **		
Primary IDE 0	Enabled	
Primary IDE 1	Enabled	
Secondary IDE 0	Enabled	
Secondary IDE 1	Enabled	
FDD, COM, LPT Port	Enabled	
PCI PIRQ[A-D] #	Enabled	

Power Supply Type

This field sets the power supply type that is in your system. By default, the setting is set to *ATX*.

ACPI Function

Enable this function to support ACPI (Advance Configuration and Power Interface).

ACPI Suspend Type

This field sets the ACPI Power Management standby state. The default setting is *SI (POS)*.

Power Management

This field allows you to select the type of power saving management modes. There are four selections for Power Management.

Min. Power Saving	Minimum power management
Max. Power Saving	Maximum power management.
User Define	Each of the ranges is from 1 min. to 1hr. Except for HDD Power Down which ranges from 1 min. to 15 min.

Video Off Method

This field defines the Video Off features. There are three options.

V/H SYNC + Blank	Default setting, blank the screen and turn off vertical and horizontal scanning.
DPMS	Allows BIOS to control the video display.
Blank Screen	Writes blanks to the video buffer.

Video Off In Suspend

When enabled, the video is off in suspend mode. The default setting is *Yes*.

Suspend Type

The default setting for the Suspend Type field is *Stop Grant*.

Modem Use IRQ

This field sets the IRQ used by the Modem. By default, the setting is **3**.

Suspend Mode

When enabled, and after the set time of system inactivity, all devices except the CPU will be shut off.

HDD Power Down

When enabled, and after the set time of system inactivity, the hard disk drive will be powered down while all other devices remain active.

Soft-Off by PWRBTN

This field defines the power-off mode when using an ATX power supply. The *Instant Off* mode allows powering off immediately upon pressing the power button. In the *Delay 4 Sec* mode, the system powers off when the power button is pressed for more than four seconds or enters the suspend mode when pressed for less than 4 seconds.

CPU THRM-Throttling

When the system enters Doze mode, the CPU clock runs only part of the time. You may select the percent of time that the clock runs.

Wake-Up by PCI Cards

Enable this field to allow wake up function through a PCI card.

Power On by Ring

This field enables or disables the power on of the system through the modem connected to the serial port or LAN.

Wake Up On CSA Lan

Enable this field to allow wake up function through the onboard CSA LAN.

Resume by Alarm

This field enables or disables the resumption of the system operation. When enabled, the user is allowed to set the *Date* and *Time*.

Reload Global Timer Events

The HDD, FDD, COM, LPT Ports, and PCI PIRQ are I/O events which can prevent the system from entering a power saving mode or can awaken the system from such a mode. When an I/O device wants to gain the attention of the operating system, it signals this by causing an IRQ to occur. When the operating system is ready to respond to the request, it interrupts itself and performs the service.

PNP/PCI Configurations

This option configures the PCI bus system. All PCI bus systems on the system use INT#, thus all installed PCI cards must be set to this value.

Phoenix - AwardBIOS CMOS Setup Utility
PnP/PCI Configurations

PNP OS Install	No	ITEM HELP Menu Level
Reset Configuration Data	Disabled	
Resources Controlled By	Auto (ESCD)	Default is Disabled. Select Enabled to reset Extended System Configuration Data (ESCD) when you exit Setup if you have installed a new add-on and the system reconfiguration has caused such a serious conflict that the OS cannot boot
IRQ Resources	Press Enter	
DMA Resources	Press Enter	
PCI/VGA Palette Snoop	Disabled	
INT Pin 1 Assignment	Auto	
INT Pin 2 Assignment	Auto	
INT Pin 3 Assignment	Auto	
INT Pin 4 Assignment	Auto	
INT Pin 5 Assignment	Auto	
INT Pin 6 Assignment	Auto	
INT Pin 7 Assignment	Auto	
INT Pin 8 Assignment	Auto	

PNP OS Install

Enable the PNP OS Install option if it is supported by the operating system installed. The default value is *No*.

Reset Configuration Data

This field allows you to determine whether to reset the configuration data or not. The default value is *Disabled*.

Resources Controlled by

This PnP BIOS can configure all of the boot and compatible devices automatically with the use of a use a PnP operating system such as Windows 95.

PCI/VGA Palette Snoop

Some non-standard VGA display cards may not show colors properly. This field allows you to set whether or not MPEG ISA/VESA VGA cards can work with PCI/VGA. When this field is enabled, a PCI/VGA can work with an MPEG ISA/VESA VGA card. When this field is disabled, a PCI/VGA cannot work with an MPEG ISA/VESA card.

PC Health Status

This section shows the parameters in determining the PC Health Status. These parameters include temperatures, fan speeds and voltages.

Phoenix - AwardBIOS CMOS Setup Utility
PC Health Status

		ITEM HELP
CPU Warning Temperature	80°C/176°F	
Current CPU Temp.	34°C/93°F	
Current System Temp.	35°C/95°F	
Current Chassis Temp.	34°C/93°F	
CPU FAN Speed	4166 RPM	
System FAN Speed	5625PM	
Chassis FAN Speed	0 RPM	
Vcore (V)	1.63V	
Vcc3(V)	3.37V	
+5(V)	5.05V	
+12(V)	12.09V	
-12(V)	(-)12.03V	
VBAT	3.21V	
5VSB(V)	5.05V	
Shutdown Temperature	Disabled	
Temperature Warning Beep	Enabled	
CPU Fan Failure Warning	Disabled	
Sys FAN Failure Warning	Disabled	
Aux FAN Failure Warning	Disabled	

CPU Warning Temperature

This field allows the user to set the temperature so that when the temperature is reached, the system sounds a warning. This function can help prevent damage to the system that is caused by overheating.

Temperatures/Fan Speeds/Voltages

These fields are the parameters of the hardware monitoring function feature of the CPU card. The values are read-only values as monitored by the system and show the PC health status.

Shutdown Temperature

This field allows the user to set the temperature by which the system automatically shuts down once the threshold temperature is reached. This function can help prevent damage to the system that is caused by overheating.

Temperature/CPU/Chassis Fan Failure Warning

When enabled, this field lets the system sounds an audible warning to the user that the CPU fan or chassis fan has malfunctioned.

Frequency/Voltage Control

This section shows the user how to configure the processor frequency.

Phoenix - AwardBIOS CMOS Setup Utility
Frequency/Voltage Control

Auto Detect PCI Clk	Disabled	ITEM HELP
Spread Spectrum	Disabled	Menu Level

Auto Detect PCI Clk

This field enables or disables the auto detection of the PCI clock.

Spread Spectrum

This field sets the value of the spread spectrum. The default setting is *Disabled*. This field is for CE testing use only.

Load Fail-Safe Defaults

This option allows you to load the troubleshooting default values permanently stored in the BIOS ROM. These default settings are non-optimal and disable all high-performance features.

Load Setup Defaults

This option allows you to load the default values to your system configuration. These default settings are optimal and enable all high performance features.

Set Supervisor/User Password

These two options set the system password. Supervisor Password sets a password that will be used to protect the system and Setup utility. User Password sets a password that will be used exclusively on the system. To specify a password, highlight the type you want and press <Enter>. The Enter Password: message prompts on the screen. Type the password, up to eight characters in length, and press <Enter>. The system confirms your password by asking you to type it again. After setting a password, the screen automatically returns to the main screen.

To disable a password, just press the <Enter> key when you are prompted to enter the password. A message will confirm the password to be disabled. Once the password is disabled, the system will boot and you can enter Setup freely.

Save & Exit Setup

This option allows you to determine whether or not to accept the modifications. If you type “Y”, you will quit the setup utility and save all changes into the CMOS memory. If you type “N”, you will return to Setup utility.

Exit Without Saving

Select this option to exit the Setup utility without saving the changes you have made in this session. Typing “Y” will quit the Setup utility without saving the modifications. Typing “N” will return you to Setup utility.

This page is intentionally left blank.

Drivers Installation

This section describes the installation procedures for software and drivers under the Windows 98, Windows NT 4.0 and Windows 2000. The software and drivers are included with the CPU card. If you find the items missing, please contact the vendor where you made the purchase. The contents of this section include the following:

Intel 865G Chipset Software Intallation Utility	54
Intel 865G Chipset Graphics Driver.....	57
Realtek AC97 Codec Audio Driver Installation	59
Intel PRO LAN Drivers Installation.....	60
ATI M7 VGA Driver Installation.....	61
ATI M9/M10 VGA Driver Installation.....	63

IMPORTANT NOTE:

After installing your Windows operating system (Windows 98/98SE/ME/2000/XP), you must install first the Intel Chipset Software Installation Utility before proceeding with the drivers installation.

Intel 865G Chipset Software Intallation Utility

The Intel 865G Chipset Drivers should be installed first before the software drivers to enable Plug & Play INF support for Intel chipset components. Follow the instructions below to complete the installation under Windows 98/98SE/ME/2000/XP.

1. Insert the CD that comes with the CPU card and the screen below would appear. Click Intel Chipsets and then Intel 865G Chipset Family Drivers.



2. Click Intel 865G Chipset Software Intallation Utility.



3. When the Welcome screen appears, click Next to continue.

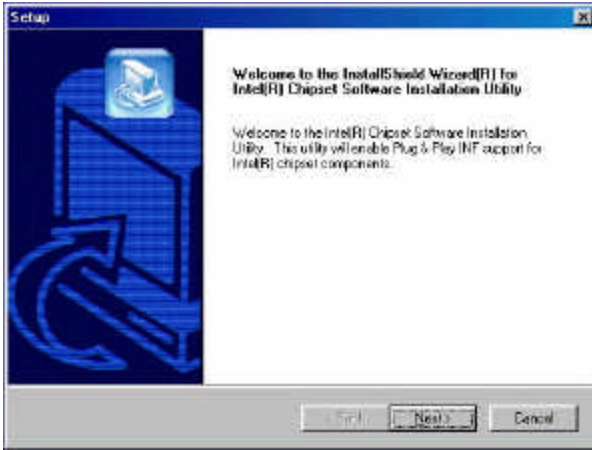

4. Click Yes to accept the software license agreement and proceed with the installation process.

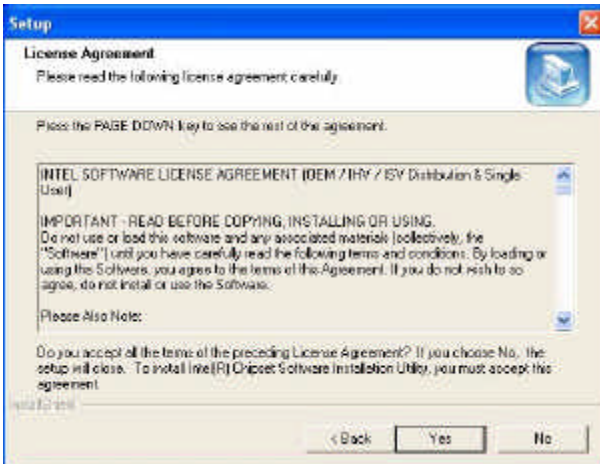

5. On Readme Information screen, click Next to continue the installation.

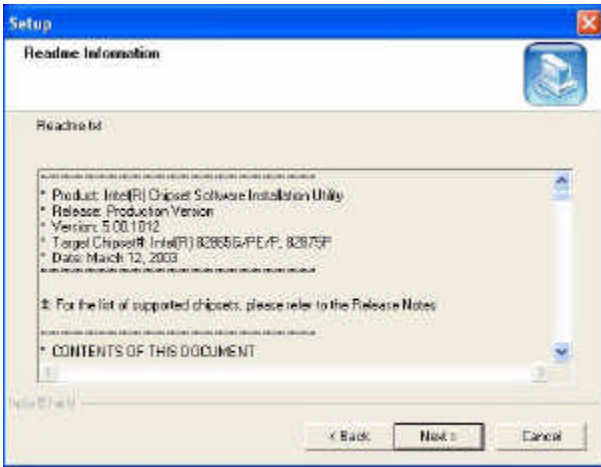

6. The Setup process is now complete. Click Finish to restart the computer and for changes to take effect. When the computer has restarted, the system will be able to find some devices. Restart your computer when prompted.

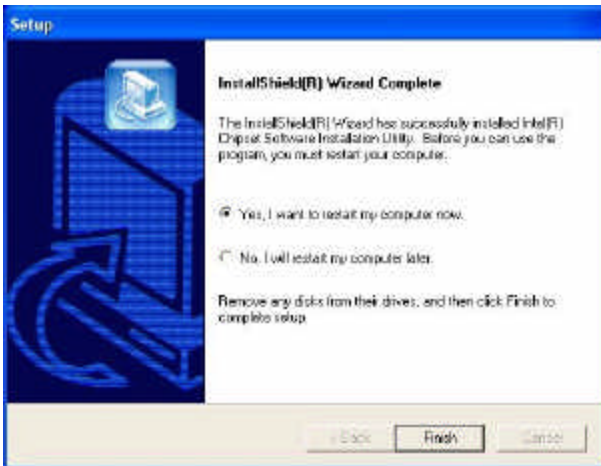

Intel 865G Chipset Graphics Driver

The Intel 865G Chipset Family Graphics Drivers come in the CD with the CPU card . Follow the instructions below to complete the installation under Windows 98/98SE/ME/2000/XP.

1. Insert the CD that comes with the CPU card and the screen below would appear. Click Intel Chipsets and then Intel 865G Chipset Family Drivers.



2. When the Welcome screen appears, click Next to continue.

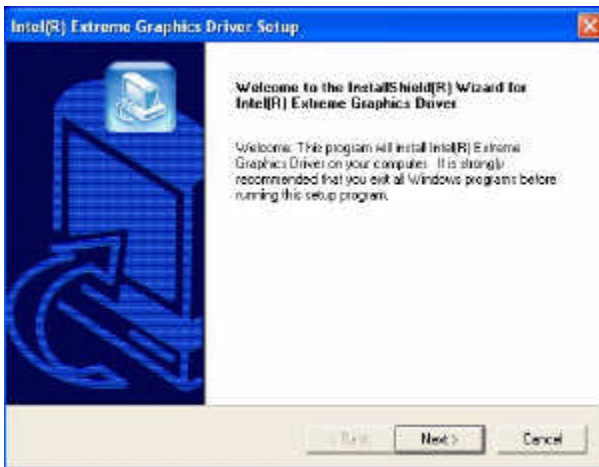

3. Click Yes to accept the software license agreement and proceed with the installation process.

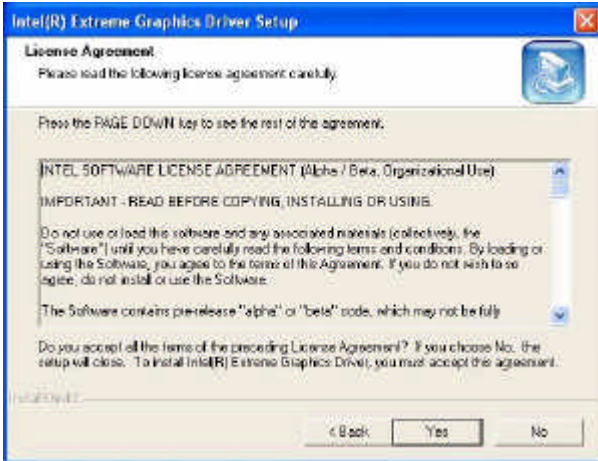

4. The Setup process is now complete. Click Finish to restart the computer and for changes to take effect. When the computer has restarted, the system will be able to find some devices. Restart your computer when prompted.

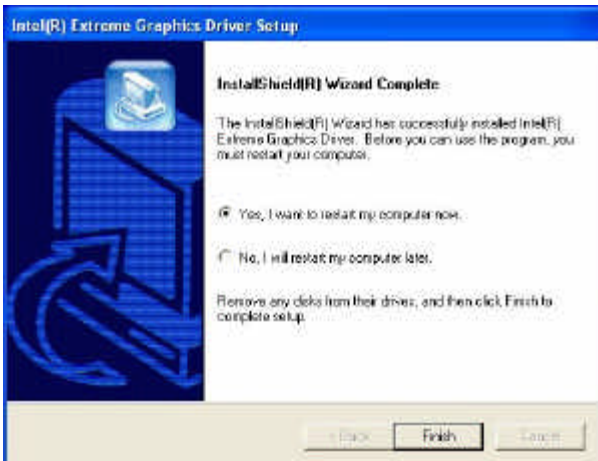

Realtek AC97 Codec Audio Driver Installation

Follow the steps below to install the Realtek AC97 Codec Audio Drivers.

1. Insert the CD that comes with the CPU card and the screen below would appear. Click Intel Chipsets, then Intel 865G Chipset Family Drivers. Click Realtek AC97 Codec Audio Drivers to start installation.

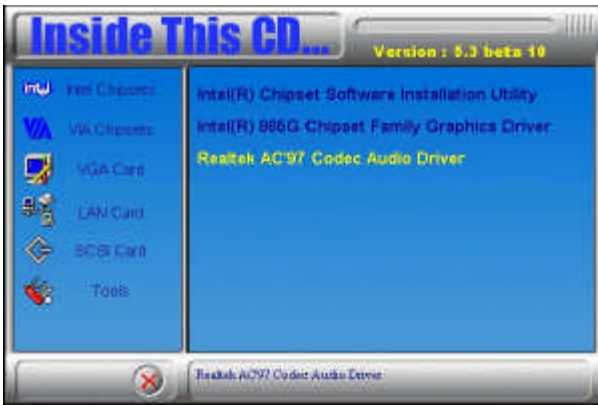

2. Click Finish to restart the computer and for changes to take effect. .

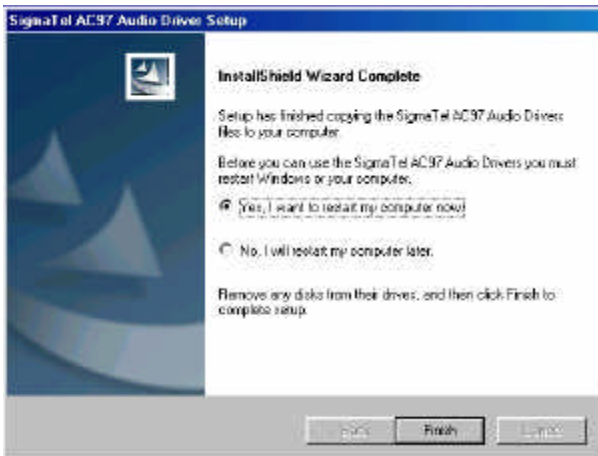

Intel PRO LAN Drivers Installation

The Intel PRO LAN drivers support both Intel® PRO/100 and PRO/1000 drivers. Follow the steps below to complete the installation.

1. Insert the CD that comes with the CPU card and the screen below would appear. Click on LAN Card on the left side to make the LAN drivers selection. Click on Intel(R) PRO LAN Drivers.



2. Click Install Now.

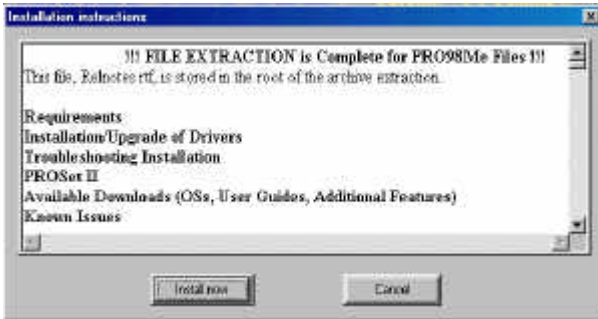

3. Click Restart to restart the computer and new settings to take effect.



ATI M7 VGA Driver Installation

1. Insert the CD that comes with the CPU card. On the initial screen, click VGA Card on the left side and the screen below would appear. Click ATI Mobility Radeon M6/M7 series VGA Driver.

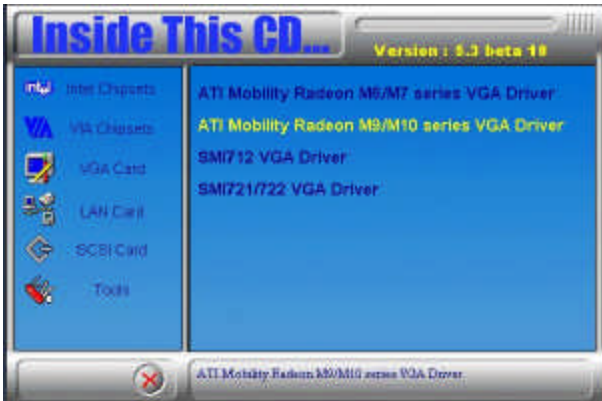

2. When the Welcome screen appears, click Next to continue.



3. Click Yes to accept the software license agreement and proceed with the installation process.

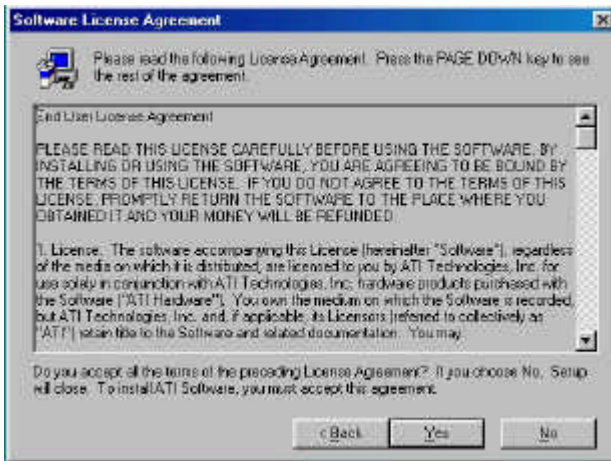

4. Select on the Express icon and click Next to continue.

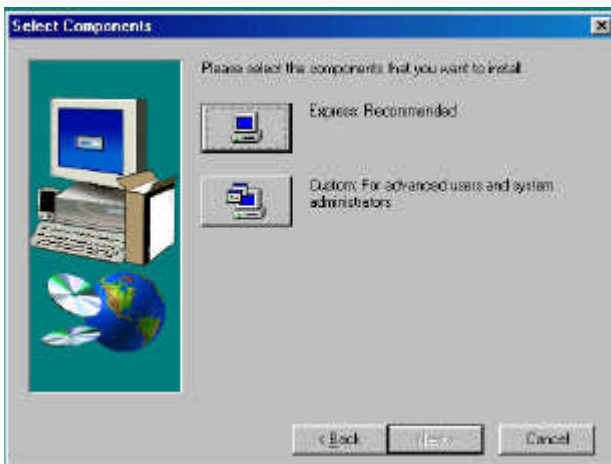

Remarks: The ATI M7 VGA controller is supported by the optional MicroAGP VGA card.

ATI M9/M10 VGA Driver Installation

1. Insert the CD that comes with the CPU card. On the initial screen, click VGA Card on the left side and the screen below would appear. Click ATI Mobility Radeon M9/M10 series VGA Driver.

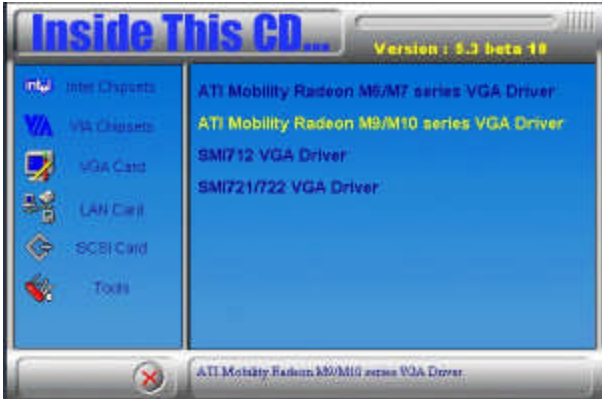

2. When the Welcome screen appears, click Next to continue.

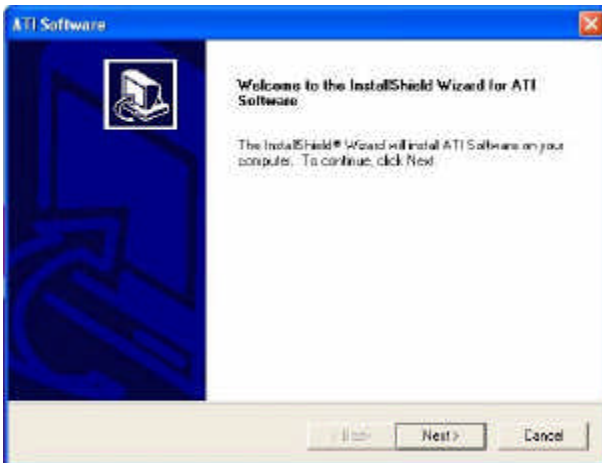

Remarks: The ATI M9 VGA controller is supported by the optional MicroAGP VGA card.

3. Click Yes to accept the software license agreement and proceed with the installation process.

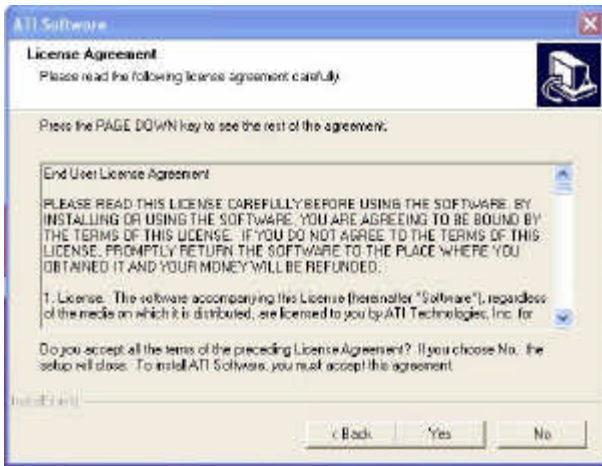

4. Click the Express icon and click Next to continue the drivers installation process.

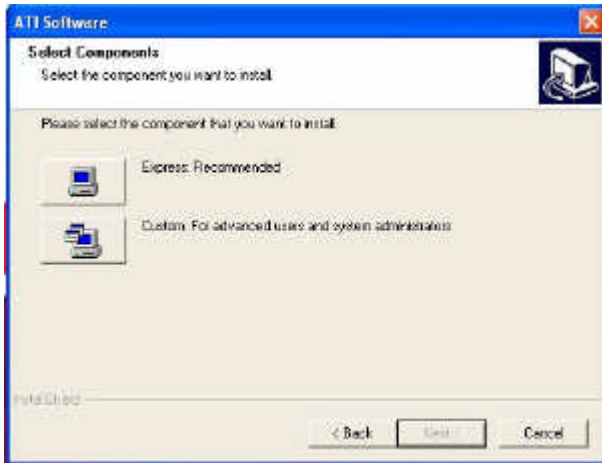

5. When the "Setup Complete" window appears, Click Finish to restart the computer and for changes to take effect.